

# Open For Business

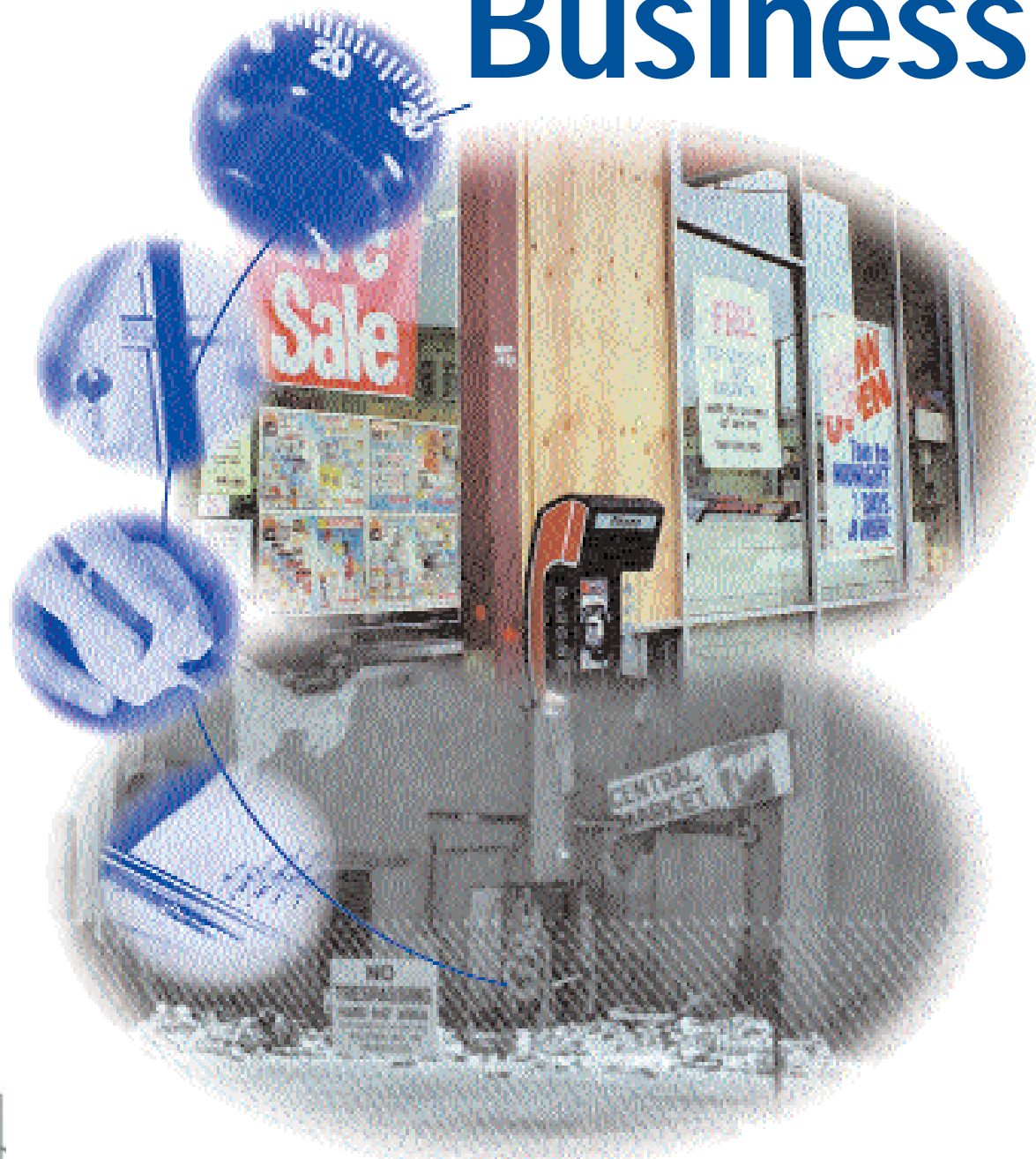

**A Disaster Planning Toolkit  
For The Small Business Owner**



October 1999

Dear Small Business Owner:

You have made a significant investment of time and resources into making your small business a success. Can you take the chance that, in spite of all your good efforts, your business may have to close due to a hurricane, an earthquake, a wildfire, a severe storm or a flood? Our estimates indicate that at least 25% of businesses never reopen following a local disaster. How do you take control of the possible impacts of a natural disaster on your business?

Here is your answer. The Institute for Business & Home Safety (IBHS) and the Small Business Administration (SBA) are pleased to present to you *Open for Business: A Disaster Planning Toolkit for the Small Business Owner*.

This kit is designed to help you:

- Identify the hazards you may face
- Plan for and reduce the impact of disasters
- Keep your doors open after a disaster hits
- Advise you on insurance, disaster supplies and the things you can do to make your business more disaster resistant

In addition, the kit contains some valuable worksheets that you can use to contact key creditors, customers, and suppliers, as well as a disaster supply checklist, an emergency contact list, and computer hardware, software and peripheral inventory sheets to help you recover from a disaster as soon as possible.

By taking the steps to protect your business now, you are also protecting one of your community's most valuable assets. Congratulations on making a decision to protect yourself, your employees and your customers from the devastating effects of a natural disaster!

Sincerely,

A handwritten signature in black ink, appearing to read 'Harvey G. Ryland'.

Harvey G. Ryland  
President & Chief Executive Officer  
Institute for Business & Home Safety

A handwritten signature in black ink, appearing to read 'Aida Alvarez'.

Aida Alvarez  
Administrator  
Small Business Administration

Prepared by the Institute for Business & Home Safety (IBHS). IBHS is an initiative of the insurance industry to reduce deaths, injuries, property damage, economic losses and human suffering caused by natural disasters. IBHS is a not-for-profit research and communications organization committed to institutionalizing natural disaster protection as a public value.

### Acknowledgments

The staff of the IBHS wishes to acknowledge the valuable input of all those who assisted in the preparation of this guide. In particular, we extend our thanks to:

- The IBHS Commercial Lines Committee
- The IBHS Information Resources Committee
- The IBHS Public Relations Committee

### Disclaimer

The purpose of this document is to provide businesses with information to assist them in increasing their protection from natural hazards. It is intended to serve only as a guide. The authors, contributors and publisher disclaim all warranties and guarantees with respect to the information in the document and assume no liability or responsibility with respect to the information.

The support given by the U.S. Small Business Administration (SBA) to this activity does not constitute an express or implied endorsement of any co-sponsor's opinions, products or services. All SBA programs are extended to the public on a nondiscriminatory basis. SBA Authorization No. 99-6050-22.

©1999 Institute for Business & Home Safety  
All rights reserved.  
ISBN 1-885312-21-0

## **Table of Contents**

<b>Safeguarding Your Investment</b>	<b>1</b>
<b>Protecting Your Critical Resources</b>	<b>2</b>
<b>What is Your Risk?</b>	<b>3</b>
<b>Conducting a Business Impact Analysis and Developing Your Recovery Plan</b>	<b>4</b>
<b>Protecting Your Building and Its Contents</b>	<b>8</b>
<b>What About Costs?</b>	<b>15</b>
<b>Conclusion</b>	<b>16</b>
<b>Additional Resources</b>	<b>17</b>
<b>References</b>	<b>18</b>
<b>IBHS Member Companies</b>	<b>19</b>
<b>Appendix</b>	
<b>Emergency Contact List</b>	
<b>Disaster Supply Checklist</b>	
<b>Insurance Coverage Discussion Form</b>	
<b>Creditor Contact Information</b>	
<b>Supplier Contact Information</b>	
<b>Key Customer Contact Information</b>	
<b>Computer Hardware Inventory</b>	
<b>Computer Software Inventory</b>	
<b>Computer Peripheral Inventory</b>	
<b>Employee Disaster Safety Poster (not supplied in PDF version)</b>	



## Safeguarding Your Investment

**You've** invested all of your time and resources into making your business work. You have a dedicated customer base. You have a good reputation for paying your suppliers and providing your goods and/or services efficiently and quickly. You are a member in good standing of your local business community.

Now, imagine that all you've worked for goes up in smoke - literally. Or that your business is hit by a flash flood. Or an earthquake. All of your efforts simply are "blown away" by a natural disaster.

Many people saw the serious damage caused by Hurricane Andrew in 1992 and the Northridge Earthquake in 1994. This means that disasters can only happen along the coast or in California, right? That's what the Bluebird Nursery in Nebraska thought, until an unexpected flood in 1984 devastated the nursery stock and nearly put the company out of business. Natural disasters, in fact, occur in every part of the country. And don't think it has to be a catastrophic event to pose serious risk to your business: a snowstorm can keep your customers and employees away. A pipe that bursts during a cold snap can destroy your inventory. An estimated 20 percent of all power outages are caused by storms. Natural disasters can happen anywhere at any time—and you need to be prepared for them.



*Photo courtesy of SAFECO.*

---

*This guide is designed to help you protect your business from the adverse effects of disasters, large or small. By integrating protection from natural disasters into your company's risk reduction measures, you will safeguard your investment for yourself, your employees, your customers and your community at large.*

*Of all businesses that close down following a disaster, at least 25 percent never reopen. Unless you protect your business from natural disasters, you risk losing it altogether.*

---



# Protecting Your Critical Resources

When you think about the impact natural disasters can have on your business, consider your most important resources:

## Human Resources

If you are the sole proprietor of your business, then you obviously need to protect yourself and your customers from possible injury in the event a disaster occurs. In small and mid-size businesses, you need to protect your employees and customers from injury on your premises. You also have to consider the possible impact a disaster will have on your employees' ability to return to work and how your customers can return to your shop or receive your goods and/or services.

## Physical Resources

Inspect your business's physical plant(s) and assess the impact a natural disaster would have on your facilities. If your business operates in an older building, consider having it evaluated by a professional engineer. An engineer's recommendations will help you safeguard your building from potential hazards. Keep in mind that an ideal time to make improvements is during a major addition or renovation.

Whether you are planning to remodel or building an entirely new facility, make sure your plans conform to local building code requirements. These codes reflect the lessons experts have learned from past catastrophes. Contact your local building code official to find out what is required for your project.

If you do not own the building your business is housed in, this is still important information for you to keep in mind if you are relocating to a new facility or expanding your business operations. The building's physical condition, and how it will survive a natural disaster, could have an impact on your ability to keep your business open following an incident.

## Business Continuity

Even if your business escapes a disaster unharmed and your employees are unhurt, there is still a risk that the business will suffer significant losses. These can be broken down into two types of losses:

**Upstream losses** are those you will suffer when one of your suppliers is affected by the disaster and cannot deliver the goods or services your business needs. Most businesses depend on daily deliveries, such as bread to a restaurant or machine parts to a manufacturer. If the supplier's building is damaged by the disaster and he cannot keep up his pre-disaster schedule, this upstream loss will affect your firm, even if it's undamaged.

**Downstream losses** occur when a key customer and/or the lives of residents in your community are affected by a disaster. If everyone in town is digging mud out of buildings and cleaning up debris after a flood, a theater won't have the same number of customers. If supplying a component to a large factory is a major source of your firm's cash flow and that factory is closed by tornado damage, your business will suffer a downstream loss even if it escaped unscathed from the disaster itself.

When some local businesses fail, there is a chain reaction because of the negative impact on the local economy. This guide will outline the steps you can take to assess risk and protect your business's assets from these disturbing possibilities.

This disaster planning guide for your small business includes some steps you can take to protect yourself from some common natural disasters you may face: earthquake, windstorm, hurricane, tornado, hail, flood, wildfire and freezing and bursting pipes.



## What is Your Risk?

Your business faces some sort of risk from natural hazard no matter where you live in the United States. Some parts of the nation are more likely to be affected by certain types of disasters than others. Here is a basic guide to the perils you may face:

### Western Region of the U.S.:

- |                  |                  |
|------------------|------------------|
| 1Avalanches      | 1Land Subsidence |
| 1Coastal Erosion | 1Landslides      |
| 1Droughts        | 1Storm Surges    |
| 1Earthquakes     | 1Tornadoes       |
| 1Extreme Heat    | 1Tsunamis        |
| 1Floods          | 1Volcanoes       |
| 1Freezing        | 1Wildfires       |
| 1Hailstorms      | 1Windstorms      |

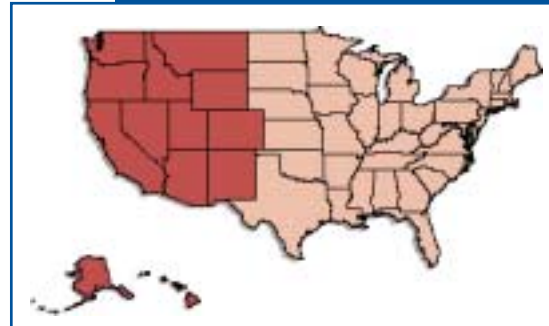

### Midwest Region of the U.S.:

- |               |                             |
|---------------|-----------------------------|
| 1Droughts     | 1Severe Thunder & Lightning |
| 1Earthquakes  | 1Severe Winter Storms       |
| 1Extreme Heat | 1Tornadoes                  |
| 1Floods       | 1Tsunamis                   |
| 1Freezing     | 1Wildfires                  |
| 1Hailstorms   | 1Windstorms                 |

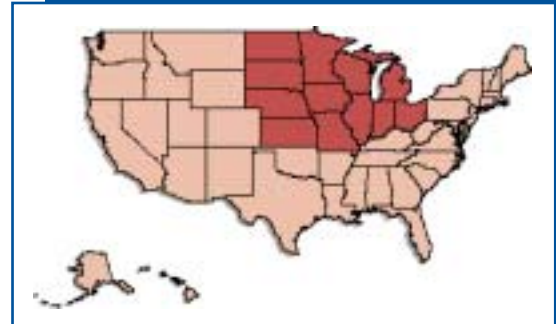

### Southern Region of the U.S.:

- |                  |                  |
|------------------|------------------|
| 1Coastal Erosion | 1Hurricanes      |
| 1Droughts        | 1Land Subsidence |
| 1Earthquakes     | 1Storm Surges    |
| 1Extreme Heat    | 1Tornadoes       |
| 1Floods          | 1Wildfires       |
| 1Freezing        | 1Windstorms      |
| 1Hailstorms      |                  |

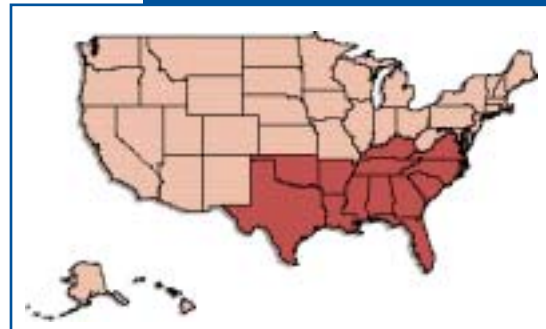

### Northeastern Region of the U.S.:

- |                  |                       |
|------------------|-----------------------|
| 1Coastal Erosion | 1Landslides           |
| 1Earthquakes     | 1Severe Winter Storms |
| 1Extreme Heat    | 1Storm Surges         |
| 1Floods          | 1Tornadoes            |
| 1Freezing        | 1Wildfires            |
| 1Hailstorms      | 1Windstorms           |
| 1Hurricanes      |                       |

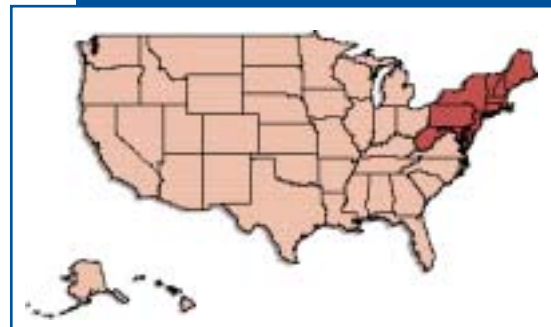



# Conducting a Business Impact Analysis and Developing Your Recovery Plan

A small investment of time will go a long way toward averting serious damage to your business and minimize the disruption a natural disaster can cause to your life and business livelihood.

No matter how small or large your business is, you should engage in a business impact analysis to identify what your operation needs to do to protect itself in the face of a natural disaster. Large corporations often hire risk managers to handle this task and some companies also hire consultants

with expertise in disaster planning and recovery to assist them with their plans. But small businesses can do the analysis and planning on their own.

The primary purpose of your business impact analysis is to determine what parts of your business need to be up and running as soon as possible. To help you get started with your business analysis and recovery plan, answer the following questions:

## General Considerations

### *What can you do to protect your building?*

If you own the structure that houses your business, integrate disaster protection for the building as well as the contents into your plan. Even if you do not own the facility, take steps to protect your assets in the event of a disaster.

*Details on protecting your building and building contents from the impact of an earthquake, windstorm, hailstorm, flood, freezing and bursting pipes, or wildfire can be found later in this guide.*

Consider the financial impact if your business shuts down as a result of a disaster. What would the impact be for a day, a week or an entire revenue period?

In addition to lost revenue, consider possible contractual fines or penalties you may face in the event you cannot meet your obligations. Negative publicity about the disaster area could impact your ability to attract customers back to your place of business. Plan to contact all of your creditors immediately following a disaster and make sure they are aware of your situation.

---

*This kit includes a Creditor Contact Information form, which you can use to make a list of the lenders you need to contact after a disaster.*

---

### *What if your suppliers are temporarily forced to shut down?*

Discuss emergency plans with your current suppliers, so you will know what to do if a disaster affects their operations. Consider making an occasional purchase with a supplier outside of your local area, so you will have a source from which to obtain critical items if your usual supplier is forced to shut down.

---

*This kit includes a Supplier Contact Information form, which you can use to make a list of your most important vendors to notify after a disaster. You can also use this list to find out what their plans are in case they are affected by a disaster.*

---



### *What if you are forced to relocate temporarily?*

Consider where you would relocate. Could you work out of your home? The temporary location will need sufficient office space and supplies. Are there rental agencies you could contact for these kinds of materials? You may need to store inventory somewhere. Essential items will have to be shipped to a new location. Make sure you have extra quantities of critical supplies on hand. If your business site suffers damage, you may need to contact an industrial cleanup service and/or a security service to protect your property. Your employees will need to know what their roles will be in setting up a temporary location. You may need to hire temporary personnel. Think through all of these questions before a disaster strikes.

### *What about insurance?*

Review your current policy with your agent. Most policies do not cover flood or earthquake damage and you may need to buy separate insurance for these perils. Be sure you understand your policy deductibles and limits.

Consider business income and extra expense insurance. Even if you have to close your doors for only a few days, the impact on your revenues and net income can be substantial. Don't assume your business will snap back to its previous revenue level as soon as you reopen. While you are closed to customers, they will go elsewhere and they may take their time finding their way back to you again. And as your revenues decrease, you will have both ongoing and new expenses. That combination can be impossible to handle without business income and extra expense coverage. Your insurance agent will work with you or your accountant to estimate your projected revenues and expenses, calculate anticipated income and then determine the potential losses from a temporary closure.

Even if your basic policy covers expenses and loss of net business income, it may not cover income interruptions due to damage that occurs away from your premises, such as to your key customer or supplier or to your utility company. You can generally buy this additional coverage and add it to your existing policy.

---

*This kit includes an Insurance Coverage Discussion Form, which you can use to review your insurance needs with your insurer.*

---

### *What records do you need?*

Make back-ups of all of your computer records and maintain them off-site. Some experts recommend that this site be at least 50 miles away from your facility. Regularly back up payroll, tax, accounting, production records and customer lists. This information is crucial following a disaster. Keep your inventory list current and consider making a photographic or videotaped record of your inventory. Make certain your on-site computers have surge protectors or an uninterrupted power supply device so your data will be protected in the event of a power outage. See to it that all of your computer hardware and software licenses are up to date and arrange with vendors to replace or repair your computer system immediately.

Also, keep some hardcopy records, such as your lease, insurance policies, etc. in a secure location (and photocopies of these in a different location).

---

*This kit includes Computer Hardware, Software and Peripheral Inventory lists, which you can use to keep a record of all of your computer resources in the event of a disaster.*

---



National Information Service for Earthquake Engineering  
University of California, Berkeley

## Protecting Yourself, Your Employees and Your Customers

### *Do your employees know about your emergency plans?*

Meet with your employees twice a year to review emergency plans. Make sure employees know how to safely evacuate the building if a disaster occurs and how to protect themselves and your customers in case of an earthquake or other disaster. Consider CPR and other emergency training.

---

*The Employee Disaster Safety poster included with this toolkit provides your employees with the information they need to protect themselves and others in the event of a disaster.*

---

### *Who do I need to contact in the event of an emergency?*

*Keep an updated list of emergency telephone numbers, including:*

- 1 Local fire department
- 1 Local police department
- 1 Ambulance services
- 1 Hospital
- 1 Building security/manager
- 1 Insurance agent
- 1 Utility companies
- 1 American Red Cross and other disaster-relief agencies

Make sure you have a contact name and telephone number in case an employee is injured. Other useful telephone numbers include government disaster-relief agencies, such as the Federal Emergency Management Agency (FEMA) and the Small Business Administration (SBA). And contact media outlets, such as newspapers and local television stations, so you can assure your customers that you have reopened or that your business will be operating again soon.

---

*This kit includes an Emergency Contact List so that you will have an immediate list of the most important telephone numbers you will need in the event of a disaster.*

---

### *What emergency supplies should I have on hand?*

Make sure you have working smoke detectors, NOAA weather radios, fire extinguishers, burglary alarms and locks securely in place before a disaster strikes.

*In addition, keep these items on hand in the event of a disaster:*

- 1 First aid kit
- 1 Flashlights/batteries
- 1 Pencils/pens
- 1 Paper towels
- 1 Waterproof plastic bags
- 1 Camera/film
- 1 Basic tool kit with wrenches, gloves, crow bar
- 1 Small supply of bottled water and nonperishable food

You should be able to put this disaster kit together for under \$100. One major purchase (more than \$500) you should consider is a multi-KV generator, pre-wired to the building's essential electrical current, which you can operate during a power outage. See the "What About Costs?" section for a more detailed discussion of costs.

---

*This kit includes a Disaster Supply Checklist so you can check off those items you need in the event of a disaster.*

---

### *How can I help my customers?*

If you plan ahead, you may be able to continue providing goods and services to your customers. If you cannot, work with your customers to provide alternative resources until you are up and running again.

---

*This kit includes a Key Customer Contact Information form so you can notify your key customers of any problems caused by a natural disaster and where your customers can obtain alternative resources until you reopen.*

---



# Protecting Your Building and Its Contents

Now that you know what natural disasters are possible in your area, look at how well your particular structure and its contents (inventory, equipment, etc.) can withstand these events. Disaster-resistant construction practices can help control your risk of serious damage for most sites. This guide will provide you with some suggestions for making your facility safer; a list of resources to help you implement these suggestions is provided at the end of each section.

If you own the structure your business is in, it's important to protect it from serious damage. But even if you don't own the building, it's vital to protect your business's contents from damage. The reason why most businesses had to close temporarily following the Northridge Earthquake was due to damage to their buildings' contents. So protecting the contents and people inside the building is extremely important.

## Earthquakes

### *Building Concerns:*

Even though we hear a lot about earthquakes on the West Coast, the reality is that earthquakes are possible in every part of the country. Many states have updated the seismic provisions of their building codes in recent years. The younger a building is, the more likely it is to have basic earthquake-resistant features incorporated into its structure. Remember, though, that the principle purpose of building codes is to protect against loss of life; a building can still suffer substantial damage even if it is designed to the latest version of the seismic code. The best advice is to have a qualified professional engineer evaluate a particular building.

### **Contents:**

#### ***You may wish to consider some or all of these actions:***

- u Anchor tall bookcases and filing cabinets to the wall studs to keep them from falling. (See diagram on page 12).
- u Brace heavily loaded racks or shelves in both directions.
- u Protect valuable or fragile items from tipping over or falling off shelving or pedestals.
- u Install latches on drawers and cabinet doors to prevent contents from falling out of them.
- u Use closed screw-eyes and wire to securely attach framed pictures and mirrors to walls.
- u Attach computers and small appliances to desks, tables or countertops with Velcro® or similar material. (See diagram on page 11).
- u Secure water heaters to the wall.
- u If allowed by your local building code, fit all gas appliances with flexible connections and/or a breakaway gas shut-off device, or have a main gas shut-off device installed. (Check with your local building department to see if a licensed professional must do this work.)
- u Make sure that you and your employees know how to safely shut off your building's utilities.
- u Attach safety cables to hanging fixtures and suspended ceilings.
- u Apply safety film to windows (minimum 4 mils). You should also apply safety film to any doors that contain panes of glass.

## Further Reading

Check the resources listed below for more information about implementing these disaster safety recommendations:

California Seismic Safety Commission. [The Commercial Property Owner's Guide to Earthquake Safety](#). Sacramento, CA: The Commission, 1998. Available from the California Seismic Safety Commission, 1900 K Street, Suite 100, Sacramento, CA 95814. Phone: (916) 322-4917; World Wide Web: <http://www.seismic.ca.gov/ssc-cog.htm>.

FM Global. [Earthquake Preparedness](#). Norwood, MA: Factory Mutual, 1996. Available from: FM Global, P.O. Box 9102, Norwood, MA 02062. Phone: (781) 255-4200; World Wide Web: [http://www.fmglobal.com/risk\\_management/disaster\\_planning/weather/earthquake.html](http://www.fmglobal.com/risk_management/disaster_planning/weather/earthquake.html).

Federal Emergency Management Agency. [Reducing the Risks of Nonstructural Earthquake Damage: A Practical Guide](#). FEMA 74. Washington, DC: FEMA, 1994. Available from the Federal Emergency Management Agency, P.O. Box 2012, Jessup, MD 20794-2012. Phone: 1-800-480-2520; World Wide Web: <http://www.fema.gov>.

Kimball, Virginia. [Earthquake Ready: The Complete Preparedness Guide](#). Malibu, CA: Roundtable Pub., 1992. Unfortunately out of print, but requests for this book can be made through large booksellers such as Amazon.com, <http://www.amazon.com>.



Photo courtesy of SAFECO.

## Windstorms

Windstorms can cause tremendous damage to property, whether it be a winter nor'easter along the coast, a hurricane or a tornado. Keep in mind that a hurricane or tornado can cause both wind and water damage.

### *Building Concerns:*

The best way to ensure that your building will safely survive a windstorm is to enlist the aid of a qualified professional engineer. Ask him/her to examine your structure for the necessary wind-resistant features.

If your business is in a hurricane-prone area, consider protecting your windows and doors against wind-borne debris by installing a permanent shutter system. If a shutter system proves impractical, you can install impact-resistant window and door systems. As a last resort, simple plywood shutters can be made in advance and be ready for installation before the storm strikes. No matter what the system, be sure you have the necessary hardware for proper installation. You can also retrofit the windows and doors to enhance their ability to resist impacts from wind-borne debris.

Also, evaluate your roof system to make sure it can weather a storm. Have a qualified design professional take a close look to determine if the roof and edge flashing are watertight and likely to resist high winds. If you are reroofing, Factory Mutual Research Corporation has developed a performance standard for commercial roofs known as the FM 4470 Roof Cover Standard. This standard includes performance tests for impacts, wind uplift, fire, leakage, weathering and corrosion.

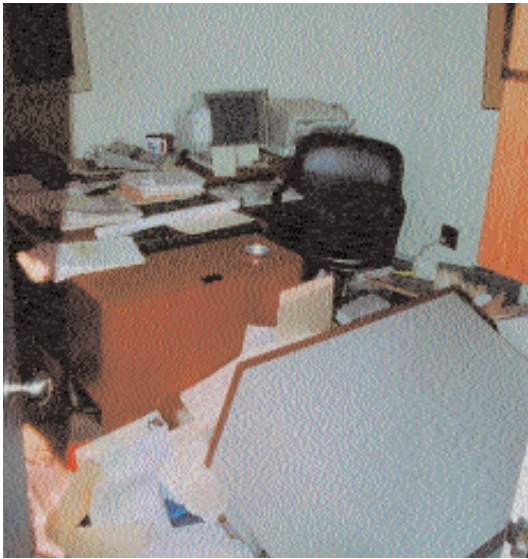

National Information Service for Earthquake Engineering  
University of California, Berkeley

### Contents:

#### You may wish to consider some or all of these actions:

- u If you are in a tornado-prone area, know in advance the safest places in your building, usually the basement. If your business is located in a high-rise building and you can't get to a basement, go to interior hallway areas and stay away from windows. Small rooms are typically safer than larger rooms. Preselect the safest place for you and your employees and make sure everyone knows this location in advance of a tornado.
- u In the case of a hurricane, prepare for possible water infiltration by covering computers, stock and other equipment with waterproof tarpaulins. Get as many items as you can off the floor or ship them out of the facility.
- u If you have time before a storm strikes, move any outdoor furniture, garbage cans and similar items inside. This will prevent them from becoming flying debris during the storm and causing damage.
- u Replace gravel/rock landscaping material with shredded bark and keep trees and shrubbery trimmed. Cut weak branches and trees that could fall or damage the building.
- u Make sure you and your employees know how to safely shut off your building's utilities.
- u Pay attention to hurricane warnings and severe weather advisories issued by the National Weather Service and local authorities. If you are in an area susceptible to tornadoes, stay alert for Tornado Watches (conditions in a given area that make a tornado likely) and Tornado Warnings (notices that a tornado has actually been spotted).

## Further Reading

Check the resources listed below for more information about implementing these disaster safety recommendations:

American Red Cross. [Are You Ready for a Tornado?](#) Washington, DC: American Red Cross 1998. Available from your local Red Cross Chapter, please check your yellow pages for the chapter nearest you. World Wide Web: <http://www.redcross.org>.

FM Global. [Riding Out the Storm.](#) Norwood, MA: Factory Mutual, 1997. Available from: FM Global, P.O. Box 9102, Norwood, MA 02062. Phone (781) 255-4681; World Wide Web [http://www.fmglobal.com/pdfs/riding\\_storm.pdf](http://www.fmglobal.com/pdfs/riding_storm.pdf).

FM Global. [Severe Windstorm Planning Guide.](#) Norwood, MA: Factory Mutual, 1997. Available from: FM Global, P.O. Box 9102, Norwood, MA 02062. Phone (781) 255-4681; World Wide Web: [http://www.fmglobal.com/pdfs/windstorm\\_planning.pdf](http://www.fmglobal.com/pdfs/windstorm_planning.pdf).

Institute for Business & Home Safety. [Metal Edge Flashing. Natural Hazard Mitigation Insights No. 10.](#) Boston, IBHS, 1999. Available from: Institute for Business & Home Safety, 1408 N. Westshore Blvd., suite 208, Tampa, FL 33607. Phone 1(866) 657-4247; Fax: 1(813) 286-9960; World Wide Web: <http://www.ibhs.org>.

Soon to be published by IBHS:

[Commercial Glazing. Natural Hazard Mitigation Insights.](#) Boston, MA: IBHS, 1999.  
[Plywood Shutters. Natural Hazard Mitigation Insights.](#) Boston, MA: IBHS, 1999.

## Hailstorms

Compared to earthquakes and hurricanes, hail might seem like a minor concern. True, hailstorms don't cause loss of life, but they can shatter windows, leave pockmarks in siding and, most important, destroy or damage roof coverings.

### Building Concerns:

If your business is housed in a commercial building, consider installing a roof that conforms to the FM 4470 roof covering test. The FM 4470 Class 1-Severe Hail (SH) Test requires roofing material to withstand the impact of a 1-3/4 inch steel ball weighing .79 pounds and dropped from a high of 17 feet, 9 inches at least ten times in different spots without causing any evidence of damage. Roofing materials that meet all of the FM performance ratings are classified as a Class 1 Rated roof system. FM performance ratings are published in the FM Approval Guide, which is published quarterly, with a cumulative volume published at the end of the year.

If your business is located in a residential structure, consider roofing that meets the new impact-resistant standard established by Underwriters Laboratories (UL 2218). The UL2218 standard rates a roof covering in classes from 1-4. Those coverings with a Class 4 rating are the most impact-resistant.

Hail is common in severe thunderstorms, so pay attention to local weather forecasts using a NOAA Weather Radio.

## Further Reading

Check the resources listed below for more information about implementing these disaster safety recommendations:

Institute for Business & Home Safety.  
[Is Your Home Protected from Hail Damage: A Homeowner's Guide to Roofing and Hail.](#) Boston: IBHS, 1999.  
Available from: Institute for Business & Home Safety, 1408 N. Westshore Blvd., suite 208, Tampa, FL 33607  
Phone 1(866) 657-4247;  
Fax: (813) 286-9960;  
World Wide Web: <http://www.ibhs.org>.

National Roofing Contractors Association. [Commercial Low-Slope Roofing Materials Guide.](#)  
1996 edition. Rosemont, IL: NRCA, 1996.  
Available from the National Roofing Contractors Association, 10255 W. Higgins Road, Suite 600, Rosemont, IL 60018-5607. Telephone: (847) 299-9070;  
World Wide Web: <http://www.nrca.net>.

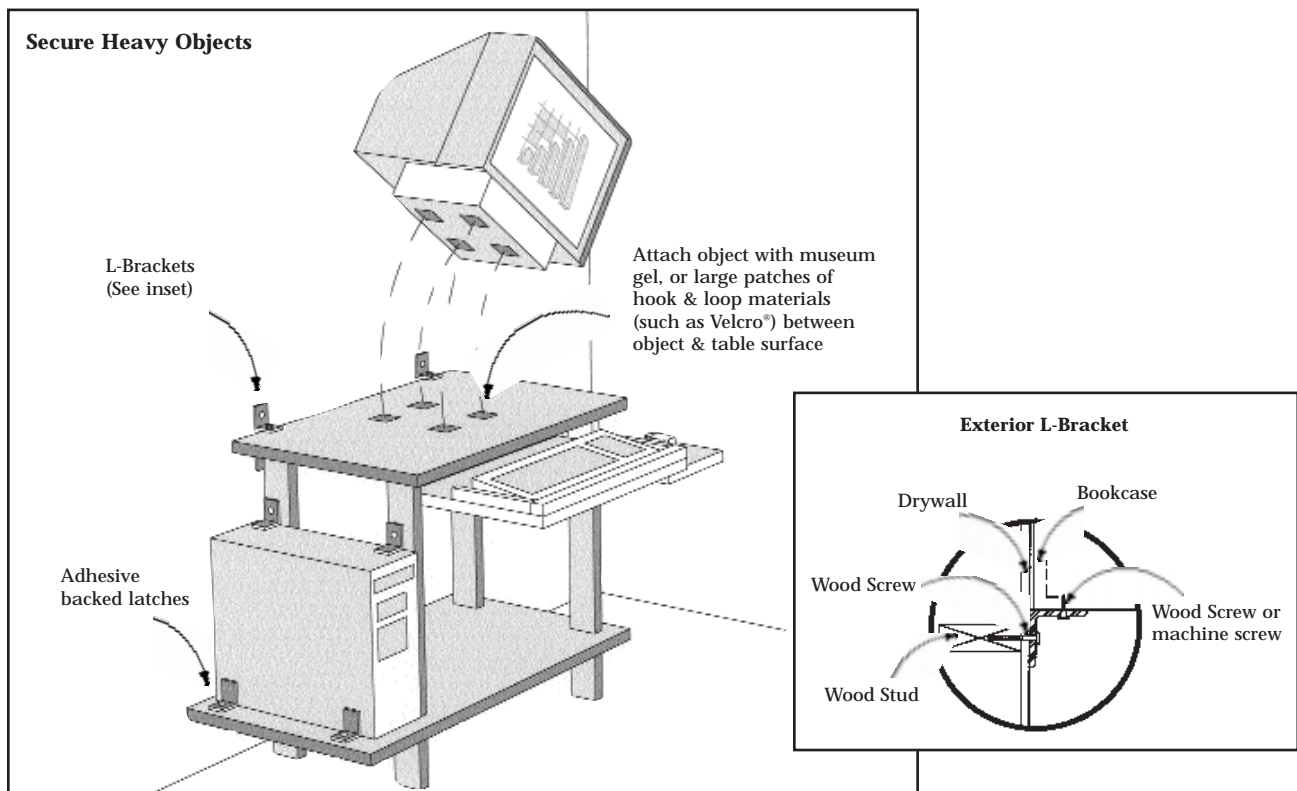

## Freezing and Bursting Pipes

Over the past decade, frozen pipes caused more than \$4.2 billion in damage to insured homes and buildings. Be sure to take special precautions when the temperature dips below 20 degrees Fahrenheit.

### Building Concerns:

- u Seal all openings with caulking or insulation where cold air can get at unprotected water pipes. It's especially important to keep cold wind away from pipes, which speeds up the freezing process.
- u If you find openings in the building to the outside, seal them with caulking or insulation.
- u Let faucets drip slowly to keep water flowing through pipes that are vulnerable to freezing. Ice might still form in the pipes, but an open faucet allows water to escape before the pressure builds and the pipe bursts. If the dripping stops, it may mean that ice is blocking the pipe; keep the faucet open, since the pipe still needs pressure relief. The blockage should not burst the pipe, since it just pushes water back toward the source.
- u Keep building temperatures above 40 degrees Fahrenheit. Every few hours, check areas that are difficult to heat.

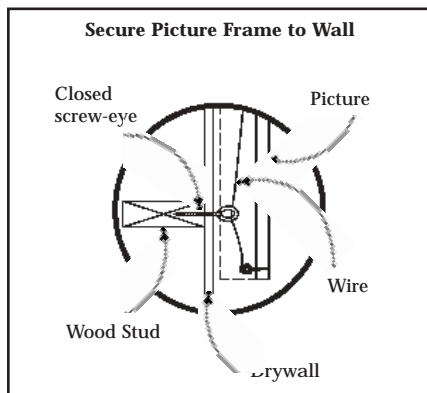

- Brackets for fastening units to walls: Use #8 (or larger) wood screws with 3" min. embedment in studs. For masonry walls: Use 3" long #8 (or larger) screws with plastic anchors or 3/16" diameter (or larger) masonry screws.
- For bracket attachment to cabinets: Use #8 (or larger) machine screws with nuts & washers.

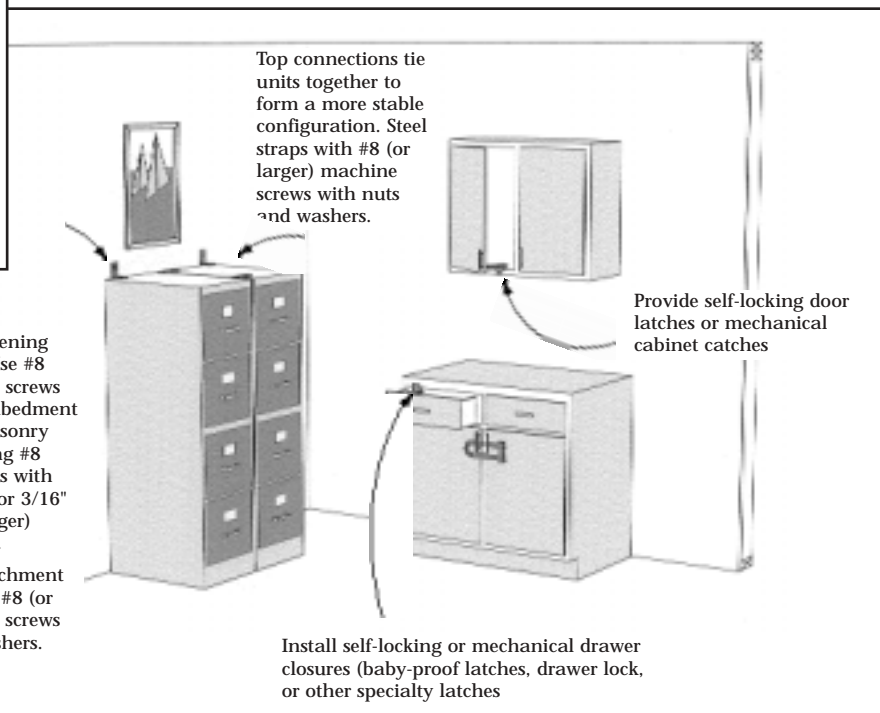

## Further Reading

Check the resources listed below for more information about implementing these disaster safety recommendations:

FM Global. [Coping with Freeze-ups and Ice Storms](#). 1999. Available from: FM Global, P.O. Box 9102, Norwood, MA 02062. Phone (781) 255-4681; World Wide Web: [http://www.fmglobal.com/risk\\_management/disaster\\_planning/weather/ice.html](http://www.fmglobal.com/risk_management/disaster_planning/weather/ice.html).

Institute for Business & Home Safety. [Freezing and Bursting Pipes](#). *Natural Hazards Mitigation Insights No.2*. Boston, MA: IBHS, 1996. Available from: Institute for Business & Home Safety, 1408 N. Westshore Blvd., suite 208, Tampa, FL 33607. Phone 1(866) 657-4247; Fax: 1(813) 286-9960; World Wide Web: <http://www.ibhs.org>.

State Farm Insurance. [Hot Tips for Preventing Cold Weather Damage](#). 1999. World Wide Web: <http://www4.statefarm.com/insuranc/homown/icedam.htm>.



## Flood

Rain, tides, levee failure, ice jam and snow melt. Floods happen. And they don't just happen on the coast or beside rivers. They happen in deserts and they happen on city streets. Floods are among the most frequent and costly natural disasters in terms of human hardship and economic loss. As much as 90 percent of the damage related to all natural disasters (excluding droughts) is caused by floods and associated debris flows.

### *Building Concerns:*

Flood-resistant construction features are only a second line of defense; the primary countermeasure is to locate your building above any expected flooding level (in other words, the "base flood elevation") or outside any flood zone. If you are in a flood-prone area, install flood shields or built-up barriers for basement windows and doors. The tops of shields should extend above the base flood elevation.



Photo courtesy of Harvey Ryland.

### **Contents:**

#### **You may wish to consider some or all of these actions:**

- u Determine whether you are in a flood zone and what type it is. Also find out what the base flood elevation (BFE) is in your area to see if floods will affect your business. Contact your city or county building department for this information. If your business is located in a special flood hazard area, take extra precautions to protect your business against floods.
- u If you have below-grade floors which are below the BFE, install and maintain a sump pump system.
- u Raise all utilities and equipment, such as the water heater, oil tanks, furnace and electric wiring, above the base flood elevation level.
- u Store inventory in areas above the base flood elevation.

*Remember a flood or flash flood watch means a flood or flash flood is possible in your area. A flood warning indicates that flooding is occurring or will occur soon. A flash flood warning means that flooding is occurring or it is imminent.*

### *Further Reading*

Check the resources listed below for more information about implementing these disaster safety recommendations:

Federal Emergency Management Agency. [Floodproofing Non-Residential Structures](#). FEMA 102. Washington, DC: FEMA, 1986. Available from: Federal Emergency Management Agency, P.O. Box 2012, Jessup, MD 20794-2012. Phone: 1-800-480-2520; World Wide Web: <http://www.fema.gov>.

FM Global. [Coping with Heavy Rains and Flooding](#). Norwood, MA: Factory Mutual, 1997. Available from: FM Global, P.O. Box 9102, Norwood, MA 02062. Phone (781) 255-4681; World Wide Web: [http://www.fmglobal.com/risk\\_management/disaster\\_planning/weather/flood.html](http://www.fmglobal.com/risk_management/disaster_planning/weather/flood.html).

## Wildfire

Learn if you are at risk from wildfire by contacting your local fire department, forestry service or other emergency response agencies. Fire protection in the wildland/urban intermix has been a problem for many years and continues to grow as the population and its desire to get closer to nature increases.

### *Building Concerns:*

The National Fire Protection Association has developed the NFPA 220: Standards on Type of Building Construction, which designates the types of construction that are the most fire resistant. The standard will give you ideas on how to minimize your vulnerability to fire. Also consult your local building official about local building codes, if you live in a wildfire-prone area.

Give your roof special attention, as it is the most vulnerable area of your building. Consider roof coverings that meet the ASTM Class A fire-resistance standard if your business is in the wildland/urban interface.

### **Contents:**

#### ***You may wish to consider some or all of these actions:***

- u Install insulated glass or multi-layered glazed panel windows or have solid exterior shutters so that radiant heat from the outside fire does not ignite flammable materials inside your building.
- u Proper landscaping of the grounds is important. Reduce the vegetation that is closest to your building and most vulnerable to catching fire. Create "fuel breaks", such as gravel walkways and driveways. Maintain at least a 100-foot clearance from your structure.
- u Also plant fire-resistant vegetation to reduce the possibility of wildfire damage in the area.
- u Store combustible material away from the building, maintaining a clearance of at least 50-feet.
- u Consult with local fire officials to make sure that your building has access to an adequate water supply in the event of a wildfire.

## Further Reading

Check the resources listed below for more information about implementing these disaster safety recommendations:

American Red Cross. [Wildfire: Are You Prepared?](#) Washington, DC: American Red Cross 1998. Available from your local Red Cross Chapter, please check your yellow pages for chapter nearest you. World Wide Web: <http://www.redcross.org>.

California Department of Forestry and Fire Protection. [Fire Safe — Inside and Out](#). Sacramento, CA: California Division of Forestry, 1996. Available from: California Department of Forestry and Fire Protection, 1416 Ninth Street, P.O. Box 944246, Sacramento, CA 94244. Telephone: (916) 227-2651; World Wide Web: <http://www.fire.ca.gov>.

Institute for Business & Home Safety. [Urban Wildfires. Natural Hazards Mitigation Insights No. 5](#). Boston, MA: IBHS, 1996. Available from: IBHS, 1408 N. Westshore Blvd., suite 208, Tampa, FL 33607. Phone 1(866) 657-4247; Fax: 1(813) 286-9960; World Wide Web: <http://www.ibhs.org>.

United States Department of Agriculture-Forest Service, et. al. [Firewise](#). 1999. World Wide Web: <http://www.firewise.org>. The most comprehensive web site for information about protection from wildfire damage.



## What About Costs?

A small business owner is always mindful of the costs that he/she will encounter when developing any strategic plan for his/her business. This list will give you some idea of the material costs you will encounter when putting together your disaster protection/recovery plan.

### No Costs

- u Identify two or three contractors or supply sources for emergency plywood window coverings.
- u Ask your insurance company or agent about policy coverage and prices.
- u Write a short check-list of recovery action items for your firm.
- u Make an appointment with the local emergency services office and fire department.
- u Elevate inventory after consulting FEMA Flood Insurance Rate Map.
- u Write a checklist for how to stay abreast of possible flood watches or warnings.
- u Instruct employees in what to do if there is a telephone outage (have the back-up number elsewhere).
- u Identify how employees can be contacted if the phone service is disrupted.
- u Establish a "rally point" in the event of a disaster.
- u Post Employee Disaster Safety posters in the workplace. (Included with this publication)

### Under \$500

- u Purchase a first aid kit.
- u Purchase a NOAA Weather Radio.
- u Buy a stock of flashlights, batteries, pens, paper, paper towels, packing tape, etc. for disaster kit.
- u Purchase/maintain camera and film.
- u Restrain desktop computers, hot water heaters, compressed gas cylinders and other small items from earthquake shaking.
- u Elevate valuable contents on shelves above base flood level.
- u Calculate the cost of business interruptions for one week, one month and six months.
- u Purchase a small back-up generator and spare fuel.
- u Maintain your sump pump, if you have one, or purchase one.
- u Store duplicate records off-site (small firm).
- u Purchase a removable computer storage device; store data off-site.
- u In a small firm (less than 10 employees), provide CPR training.
- u Purchase minimal emergency supplies for 10 or fewer employees.
- u Purchase plywood shutters.

### More than \$500

- u Purchase and install a multi-KV generator, pre-wired to the building's essential electrical circuits.
- u Install permanent shutters over windows or retrofit the windows to enhance their resistance to wind-borne debris.
- u Reroof with an impact-resistant roof covering, strongly attached to resist high wind.
- u Reroof with Class A fire-resistant roof covering, in wildfire-prone areas.
- u Hire an engineer to evaluate the wind or seismic resistance of a building.
- u Provide CPR training for employees in medium-sized and large firms.
- u Maintain emergency supplies for more than 10 employees.
- u Conduct a one-hour drill simulating the occurrence of a tornado, flood, or other hazard.
- u Send the key safety/emergency response employee to several days of training or conferences.
- u Purchase additional insurance (business interruption, flood, earthquake).
- u Store duplicate records off-site at secure facility (in a larger firm).
- u Establish a phone voice-mail system, if your business does not have one.

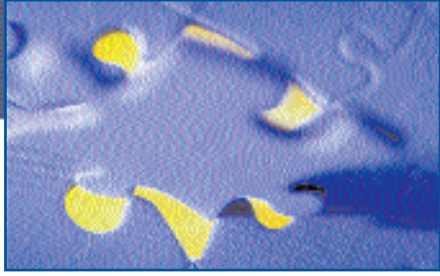

## Conclusion

**Y**our business means jobs for local residents and security for their families. It means a sound tax base for local government. It means a healthier local economy. In short, it means more than just your investment, although that alone is important enough. When you protect your business from natural disasters, you are also protecting one of your community's most valuable assets. There is no way to prevent a natural disaster from occurring. You can, however, take action to avoid the most devastating damage that your business may face. Use this guide to start planning for a disaster now, so your business and community can continue to live in harmony with the forces of nature.



## Additional Resources

### *Small Business Administration*

3rd Street, SW  
Washington, DC 20416  
Tel: 202-205-6734  
<http://www.sba.gov>

The SBA provides disaster relief via loans to qualifying businesses after disasters. The SBA also offers some publications that can assist businesses in preparing for and dealing with the effects of disasters.

### *American Red Cross*

11th Floor  
1621 N Kent Street  
Arlington, VA 22209  
Tel: 703-248-4222  
<http://www.redcross.org>

Contact your local Red Cross chapter for publications on disaster planning for yourself and your employees. The Red Cross also offers emergency training.

### *Federal Emergency Management Agency*

500 C Street, SW  
Washington, DC 20472  
Tel: 1-800-480-2520  
<http://www.fema.gov>

FEMA publishes many publications that may be helpful to businesses. You can obtain a catalog at the above number, and most of the publications are free of charge.

### *Insurance Agent or Company*

Your agent can assist you in making sure you have adequate coverages for losses due to disasters.

### *Institute for Business & Home Safety*

1408 N. Westshore Blvd., suite 208  
Tampa, FL 33607  
Tel: 1-866-657-4247  
<http://www.ibhs.org>

IBHS is an initiative of the insurance industry to reduce deaths, injuries, property damage and economic losses due to natural disasters. IBHS offers publications on reducing damage to structures; many can be downloaded free of charge from the IBHS Web site.

### *Disaster Recovery Business Alliance*

### *Association of Contingency Planners International*

7044 South 13th Street  
Oak Creek, WI 53154  
Tel: 1-800-445-4ACP  
<http://www.acp-international.com/drba/>

Created in local communities, the objective of a Disaster Recovery Business Alliance (DRBA) is to bring together the leadership and expertise of business, emergency preparedness, the engineering and scientific community and others to develop a public/private partnership approach to reducing the vulnerability of businesses and the community's marketplace to natural hazards.

### *National Emergency Management Association*

c/o Council of State Governments  
P.O. Box 11910  
Lexington, KY 40578  
Telephone: (606) 244-8000  
Fax: (606) 244-8239  
<http://www.nemaweb.media3.net/index.cfm>

NEMA is the professional association of state emergency management directors.

Consult your local emergency management agency for additional information regarding the natural hazards that your business may face.

Check your telephone book for your local chamber of commerce; a directory of chambers can be found on the World Wide Web at:  
<http://clickcity.com/index2.htm>

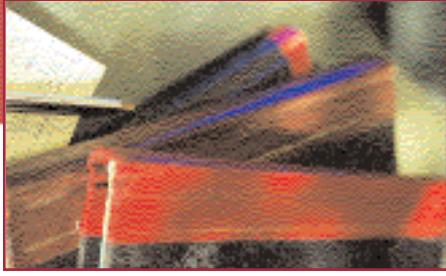

## References

Barrier, Michael. "Planning for a Disaster." Nation's Business, May 1998, p. 51-52.

Bell Atlantic. "Continuity Planning (Statistics). Commguard-Business Services."  
<http://www.bell-atl.com/business/commguard/cp3.htm>.

Ianna, Frank. "Disaster Recovery for Businesses." Disaster Recovery Journal, Summer 1997, pp.39-42.

Derived from: Federal Emergency Management Agency. Multihazard Identification and Risk Assessment: The cornerstone of the National Mitigation Strategy. Washington, DC: FEMA, 1997.

Tierney, Kathleen J. Business Impacts of the Northridge Earthquake. Dover, Delaware: The Disaster Research Center, University of Delaware, 1996.

## IBHS Members

Alfa Insurance Group  
Alliance Insurance Companies  
Allstate Insurance Group  
American Agricultural Insurance Company  
American Family Insurance Group  
American Re-Insurance Company  
Amica Mutual Insurance Company  
Andover Group  
Auto Club South Insurance Company  
Automobile Club Insurance Association  
Baldwin Mutual Insurance Company  
Bankers Insurance Group  
Barnstable Group  
Brethren Mutual Insurance Company  
California State Auto Association Inter-Insurance Bureau  
Chubb Group of Insurance Companies  
CIGNA Group  
Cincinnati Financial Corporation  
CNA Insurance Companies  
Colonial Penn Group  
Concord Group Insurance Companies  
Country Companies  
EMC Insurance Companies  
Employers Insurance of Wausau - A Mutual Company  
Farm Bureau Group of Iowa  
Farmers Insurance Group  
FCCI Insurance Group  
First Delaware Insurance Company  
First Floridian Auto and Home Insurance Company  
Florida Family Mutual Insurance Company  
Florida Farm Bureau Casualty Insurance Company  
FM Global  
Foremost Corporation Group  
General Re Group  
Gerling Global Reinsurance Corporation of America  
Germania Mutual Group  
Grange Mutual Insurance Company (OR)  
Harleysville Insurance Companies  
Hartford Financial Services Group  
The Hartford Steam Boiler Group  
Holyoke Mutual Insurance Company in Salem  
IPC Re Ltd.  
Kemper Insurance Companies  
Keystone Insurance Companies  
LaSalle Re Ltd.  
Liberty Mutual Group  
Maine Mutual Fire Insurance Company  
Merastar Insurance Company  
Metropolitan Group  
Millers Mutual Insurance Company  
Montgomery Insurance Companies  
Motor Club of America Group  
Mutual Assurance Society of Virginia  
Mutual of Enumclaw Insurance Company  
Mutual of Omaha Group  
NAC Reinsurance Corporation  
National Grange Mutual Insurance Company  
Nationwide Insurance  
North Pointe Insurance Company  
Oregon Mutual Group  
Orion Capital Companies  
Patrons Mutual Group of Connecticut  
PEMCO Insurance Companies  
Piedmont Mutual Insurance Company  
PMA Reinsurance Corporation  
Prudential of America Group  
Redland Insurance Group  
Reinsurance Association of Minnesota  
Renaissance Reinsurance Ltd.  
Rockingham Group  
Royal & SunAlliance U.S.A.  
SAFECO Insurance Companies  
Selective Insurance Group  
Service Insurance Company  
Sorema N.A. Reinsurance Company  
South Carolina Farm Bureau Mutual Insurance Company  
Southern Family Insurance Company  
Southern Mutual Church Insurance Company  
State Farm Group  
Swiss Reinsurance Group  
Tempest Reinsurance Company Ltd.  
TIG Holdings Group  
The Toa Reinsurance Company of America  
Union American Insurance Company  
Union Insurance Company  
United Farm Bureau of Indiana Group  
USAA Group  
Utica First Insurance Company  
X.L. Mid Ocean Reinsurance Company Ltd.  
Zurich Personal Insurance

# Appendix





## ***Open for Business Worksheet*** **Emergency Contact List**

***Keep this emergency contact list available for you and your employees in the event of an emergency.  
Attach a list of employee emergency contact numbers to this list.***

Local Police Department: \_\_\_\_\_

Local Fire Department: \_\_\_\_\_

Ambulance Service: \_\_\_\_\_

Hospital: \_\_\_\_\_

Insurance Company: \_\_\_\_\_

Agent: \_\_\_\_\_

Policy Number: \_\_\_\_\_

Telephone Company: \_\_\_\_\_

Gas/Heat Company: \_\_\_\_\_

Electric Company: \_\_\_\_\_

Building Manager: \_\_\_\_\_

Building Security: \_\_\_\_\_

Local Small Business Administration Office: \_\_\_\_\_

Federal Emergency Management Agency Regional Office: \_\_\_\_\_

Local Newspaper: \_\_\_\_\_

\_\_\_\_\_

\_\_\_\_\_

Local Radio Stations: \_\_\_\_\_

\_\_\_\_\_

\_\_\_\_\_

\_\_\_\_\_

Local Televisions Stations: \_\_\_\_\_

\_\_\_\_\_

\_\_\_\_\_



## *Open for Business Worksheet* **Disaster Supply Checklist**

*Use this check-off list to ensure you have all the supplies you need in the event of a disaster.*

NOAA Weather Radio	p
First Aid Kit	p
Flashlights/Batteries	p
Waterproof Plastic Bags	p
Camera/Film	p
Pens/Pencils/Paper	p
Water/Food Supplies	p
Generator	p
Mops/Pails/etc.	p
Tool Kit (basic tools, gloves, etc.)	p
Contact Sheets	p
Other _____	p
_____	p
_____	p
_____	p



**Open for Business Worksheet**  
**Insurance Coverage Discussion Form**

*Use this form to discuss your insurance coverage with your agent. Having adequate coverage now will help you recover more rapidly from a catastrophe.*

Insurance Agent: \_\_\_\_\_

Address: \_\_\_\_\_

Phone: \_\_\_\_\_ Fax: \_\_\_\_\_ Email: \_\_\_\_\_

**INSURANCE POLICY INFORMATION**

Type of Insurance	Policy No.	Deductibles	Policy Limits	Coverage (General Description)

Do you need Flood Insurance? Yes  No

Do you need Earthquake Insurance? Yes  No

Do you need Business Income and Extra Expense Insurance? Yes  No

Other disaster-related insurance questions:  
 \_\_\_\_\_  
 \_\_\_\_\_  
 \_\_\_\_\_  
 \_\_\_\_\_



## Open for Business Worksheet Creditor Contact Information



**Use this form to keep a list of the major creditors you need to contact in the event of a disaster.  
Make additional copies as needed.**

**Keep one copy of this list in a secure place on your premises and another in an off-site location.**

### CREDITORS

Bank Name: \_\_\_\_\_

Street Address: \_\_\_\_\_

City \_\_\_\_\_ State \_\_\_\_\_ Zip Code \_\_\_\_\_

Phone: \_\_\_\_\_ Fax: \_\_\_\_\_ E-mail: \_\_\_\_\_

Contact Name: \_\_\_\_\_ Account Number: \_\_\_\_\_

Bank Name: \_\_\_\_\_

Street Address: \_\_\_\_\_

City \_\_\_\_\_ State \_\_\_\_\_ Zip Code \_\_\_\_\_

Phone: \_\_\_\_\_ Fax: \_\_\_\_\_ E-mail: \_\_\_\_\_

Contact Name: \_\_\_\_\_ Account Number: \_\_\_\_\_

Company Name: \_\_\_\_\_

Street Address: \_\_\_\_\_

City \_\_\_\_\_ State \_\_\_\_\_ Zip Code \_\_\_\_\_

Phone: \_\_\_\_\_ Fax: \_\_\_\_\_ E-mail: \_\_\_\_\_

Contact Name: \_\_\_\_\_ Account Number: \_\_\_\_\_

Company Name: \_\_\_\_\_

Street Address: \_\_\_\_\_

City \_\_\_\_\_ State \_\_\_\_\_ Zip Code \_\_\_\_\_

Phone: \_\_\_\_\_ Fax: \_\_\_\_\_ E-mail: \_\_\_\_\_

Contact Name: \_\_\_\_\_ Account Number: \_\_\_\_\_

Company Name: \_\_\_\_\_

Street Address: \_\_\_\_\_

City \_\_\_\_\_ State \_\_\_\_\_ Zip Code \_\_\_\_\_

Phone: \_\_\_\_\_ Fax: \_\_\_\_\_ E-mail: \_\_\_\_\_

Contact Name: \_\_\_\_\_ Account Number: \_\_\_\_\_

Company Name: \_\_\_\_\_

Street Address: \_\_\_\_\_

City \_\_\_\_\_ State \_\_\_\_\_ Zip Code \_\_\_\_\_

Phone: \_\_\_\_\_ Fax: \_\_\_\_\_ E-mail: \_\_\_\_\_

Contact Name: \_\_\_\_\_ Account Number: \_\_\_\_\_



## *Open for Business Worksheet* **Supplier Contact Information**

**Use this form to:**

1. Keep a list of the major suppliers you need to contact in the event of a disaster, and
2. Know what their disaster plans are in the event that they experience a disaster.

Make additional copies as needed.

**Keep one copy of this list in a secure place on your premises and another in an off-site location.**

### SUPPLIERS

1. Company Name: \_\_\_\_\_  
 Street Address: \_\_\_\_\_  
 City \_\_\_\_\_ State \_\_\_\_\_ Zip Code \_\_\_\_\_  
 Phone: \_\_\_\_\_ Fax: \_\_\_\_\_ E-mail: \_\_\_\_\_  
 Contact Name: \_\_\_\_\_ Account Number: \_\_\_\_\_  
 Materials/Service Provided: \_\_\_\_\_

**If this company experiences a disaster, we will obtain supplies/materials from the following:**

1A. Company Name: \_\_\_\_\_  
 Street Address: \_\_\_\_\_  
 City \_\_\_\_\_ State \_\_\_\_\_ Zip Code \_\_\_\_\_  
 Phone: \_\_\_\_\_ Fax: \_\_\_\_\_ E-mail: \_\_\_\_\_  
 Contact Name: \_\_\_\_\_ Account Number: \_\_\_\_\_

2. Company Name: \_\_\_\_\_  
 Street Address: \_\_\_\_\_  
 City \_\_\_\_\_ State \_\_\_\_\_ Zip Code \_\_\_\_\_  
 Phone: \_\_\_\_\_ Fax: \_\_\_\_\_ E-mail: \_\_\_\_\_  
 Contact Name: \_\_\_\_\_ Account Number: \_\_\_\_\_  
 Materials/Service Provided: \_\_\_\_\_

**If this company experiences/ a disaster, we will obtain supplies/materials from the following:**

2A. Company Name: \_\_\_\_\_  
 Street Address: \_\_\_\_\_  
 City \_\_\_\_\_ State \_\_\_\_\_ Zip Code \_\_\_\_\_  
 Phone: \_\_\_\_\_ Fax: \_\_\_\_\_ E-mail: \_\_\_\_\_  
 Contact Name: \_\_\_\_\_ Account Number: \_\_\_\_\_



3. Company Name: \_\_\_\_\_  
Street Address: \_\_\_\_\_  
City \_\_\_\_\_ State \_\_\_\_\_ Zip Code \_\_\_\_\_  
Phone: \_\_\_\_\_ Fax: \_\_\_\_\_ E-mail: \_\_\_\_\_  
Contact Name: \_\_\_\_\_ Account Number: \_\_\_\_\_  
Materials/Service Provided: \_\_\_\_\_

**If this company experiences a disaster, we will obtain supplies/materials from the following:**

3A. Company Name: \_\_\_\_\_  
Street Address: \_\_\_\_\_  
City \_\_\_\_\_ State \_\_\_\_\_ Zip Code \_\_\_\_\_  
Phone: \_\_\_\_\_ Fax: \_\_\_\_\_ E-mail: \_\_\_\_\_  
Contact Name: \_\_\_\_\_ Account Number: \_\_\_\_\_

4. Company Name: \_\_\_\_\_  
Street Address: \_\_\_\_\_  
City \_\_\_\_\_ State \_\_\_\_\_ Zip Code \_\_\_\_\_  
Phone: \_\_\_\_\_ Fax: \_\_\_\_\_ E-mail: \_\_\_\_\_  
Contact Name: \_\_\_\_\_ Account Number: \_\_\_\_\_  
Materials/Service Provided: \_\_\_\_\_

**If this company experiences a disaster, we will obtain supplies/materials from the following:**

4A. Company Name: \_\_\_\_\_  
Street Address: \_\_\_\_\_  
City \_\_\_\_\_ State \_\_\_\_\_ Zip Code \_\_\_\_\_  
Phone: \_\_\_\_\_ Fax: \_\_\_\_\_ E-mail: \_\_\_\_\_  
Contact Name: \_\_\_\_\_ Account Number: \_\_\_\_\_



## Open for Business Worksheet

### Key Customer Information

**Use this form to:**

1. Keep a list of your key customers that you need to contact in the event of a disaster, and
2. Where these customers can obtain alternative resources until you reopen.

Make additional copies as needed.

**Keep one copy of this list in a secure place on your premises and another in an off-site location.**

### CUSTOMERS

1. Company Name: \_\_\_\_\_  
Street Address: \_\_\_\_\_  
City \_\_\_\_\_ State \_\_\_\_\_ Zip Code \_\_\_\_\_  
Phone: \_\_\_\_\_ Fax: \_\_\_\_\_ E-mail: \_\_\_\_\_  
Contact Name: \_\_\_\_\_ Account Number: \_\_\_\_\_

**If my company experiences a disaster, my customer will obtain supplies/materials from the following:**

1A. Company Name: \_\_\_\_\_  
Street Address: \_\_\_\_\_  
City \_\_\_\_\_ State \_\_\_\_\_ Zip Code \_\_\_\_\_  
Phone: \_\_\_\_\_ Fax: \_\_\_\_\_ E-mail: \_\_\_\_\_  
Contact Name: \_\_\_\_\_ Account Number: \_\_\_\_\_

2. Company Name: \_\_\_\_\_  
Street Address: \_\_\_\_\_  
City \_\_\_\_\_ State \_\_\_\_\_ Zip Code \_\_\_\_\_  
Phone: \_\_\_\_\_ Fax: \_\_\_\_\_ E-mail: \_\_\_\_\_  
Contact Name: \_\_\_\_\_ Account Number: \_\_\_\_\_

**If my company experiences a disaster, my customer will obtain supplies/materials from the following:**

2A. Company Name: \_\_\_\_\_  
Street Address: \_\_\_\_\_  
City \_\_\_\_\_ State \_\_\_\_\_ Zip Code \_\_\_\_\_  
Phone: \_\_\_\_\_ Fax: \_\_\_\_\_ E-mail: \_\_\_\_\_  
Contact Name: \_\_\_\_\_ Account Number: \_\_\_\_\_



3. Company Name: \_\_\_\_\_  
Street Address: \_\_\_\_\_  
City \_\_\_\_\_ State \_\_\_\_\_ Zip Code \_\_\_\_\_  
Phone: \_\_\_\_\_ Fax: \_\_\_\_\_ E-mail: \_\_\_\_\_  
Contact Name: \_\_\_\_\_ Account Number: \_\_\_\_\_

**If my company experiences a disaster, my company will obtain supplies/materials from the following:**

3A. Company Name: \_\_\_\_\_  
Street Address: \_\_\_\_\_  
City \_\_\_\_\_ State \_\_\_\_\_ Zip Code \_\_\_\_\_  
Phone: \_\_\_\_\_ Fax: \_\_\_\_\_ E-mail: \_\_\_\_\_  
Contact Name: \_\_\_\_\_ Account Number: \_\_\_\_\_

4. Company Name: \_\_\_\_\_  
Street Address: \_\_\_\_\_  
City \_\_\_\_\_ State \_\_\_\_\_ Zip Code \_\_\_\_\_  
Phone: \_\_\_\_\_ Fax: \_\_\_\_\_ E-mail: \_\_\_\_\_  
Contact Name: \_\_\_\_\_ Account Number: \_\_\_\_\_

**If my company experiences a disaster, my company will obtain supplies/materials from the following:**

4A. Company Name: \_\_\_\_\_  
Street Address: \_\_\_\_\_  
City \_\_\_\_\_ State \_\_\_\_\_ Zip Code \_\_\_\_\_  
Phone: \_\_\_\_\_ Fax: \_\_\_\_\_ E-mail: \_\_\_\_\_  
Contact Name: \_\_\_\_\_ Account Number: \_\_\_\_\_







**COMPUTER HARDWARE INVENTORY (continued):**



**Hardware Vendor or Leasing Company Information**

Company Name: \_\_\_\_\_

Street Address: \_\_\_\_\_

City \_\_\_\_\_ State \_\_\_\_\_ Zip Code \_\_\_\_\_

Phone: \_\_\_\_\_

Fax: \_\_\_\_\_

E-mail: \_\_\_\_\_

Contact Name: \_\_\_\_\_

Account Number: \_\_\_\_\_

**Hardware Supplier/Repair Vendor Information**

Company Name: \_\_\_\_\_

Street Address: \_\_\_\_\_

City \_\_\_\_\_ State \_\_\_\_\_ Zip Code \_\_\_\_\_

Phone: \_\_\_\_\_

Fax: \_\_\_\_\_

E-mail: \_\_\_\_\_

Contact Name: \_\_\_\_\_

Account Number: \_\_\_\_\_





**COMPUTER SOFTWARE INVENTORY (continued):**



**Software Vendor or Leasing Company Information**

Company Name: \_\_\_\_\_

Street Address: \_\_\_\_\_

City \_\_\_\_\_ State \_\_\_\_\_ Zip Code \_\_\_\_\_

Phone: \_\_\_\_\_

Fax: \_\_\_\_\_

E-mail: \_\_\_\_\_

Contact Name: \_\_\_\_\_

Account Number: \_\_\_\_\_

**Off-Site Data Backup Information**

Company Name: \_\_\_\_\_

Street Address: \_\_\_\_\_

City \_\_\_\_\_ State \_\_\_\_\_ Zip Code \_\_\_\_\_

Phone: \_\_\_\_\_

Fax: \_\_\_\_\_

E-mail: \_\_\_\_\_

Contact Name: \_\_\_\_\_

Account Number: \_\_\_\_\_





**COMPUTER PERIPHERAL INVENTORY (continued):**

**Peripheral Vendor or Leasing Company Information**

Company Name: \_\_\_\_\_

Street Address: \_\_\_\_\_

City \_\_\_\_\_ State \_\_\_\_\_ Zip Code \_\_\_\_\_

Phone: \_\_\_\_\_

Fax: \_\_\_\_\_

E-mail: \_\_\_\_\_

Contact Name: \_\_\_\_\_

Account Number: \_\_\_\_\_

**Peripheral Support Vendor Information**

Company Name: \_\_\_\_\_

Street Address: \_\_\_\_\_

City \_\_\_\_\_ State \_\_\_\_\_ Zip Code \_\_\_\_\_

Phone: \_\_\_\_\_

Fax: \_\_\_\_\_

E-mail: \_\_\_\_\_

Contact Name: \_\_\_\_\_

Account Number: \_\_\_\_\_

